

CALPLAS PUMP STRAINERS

P4 / P8 / P15 / P25 / P60 / P75



Main Characteristics

Pump Strainer in polyester	Connection type: Flanges / Treads (customer's selection)
Basket size: From 4 lts (P4) up to 75 lts (P75)	
Lid: Transparent & Quick Opening	Connection size: Inlet / Outlet customer's selection
Basket hole diameter: Ø 2 / 4 mm	Connection position: Customer's selection

Materials

Body: Laminated polyester reinforced with fiberglass	Screws : Stainless Steel
Inlet/Outlet: Laminated polyester threads (GAS) / Flanges	Top Lid: Methacrylate (transparent)
Basket: Stainless steel 304 / 316	

Manufacturing

Laminated polyester: Manually oriented fibers according to maximum strengths

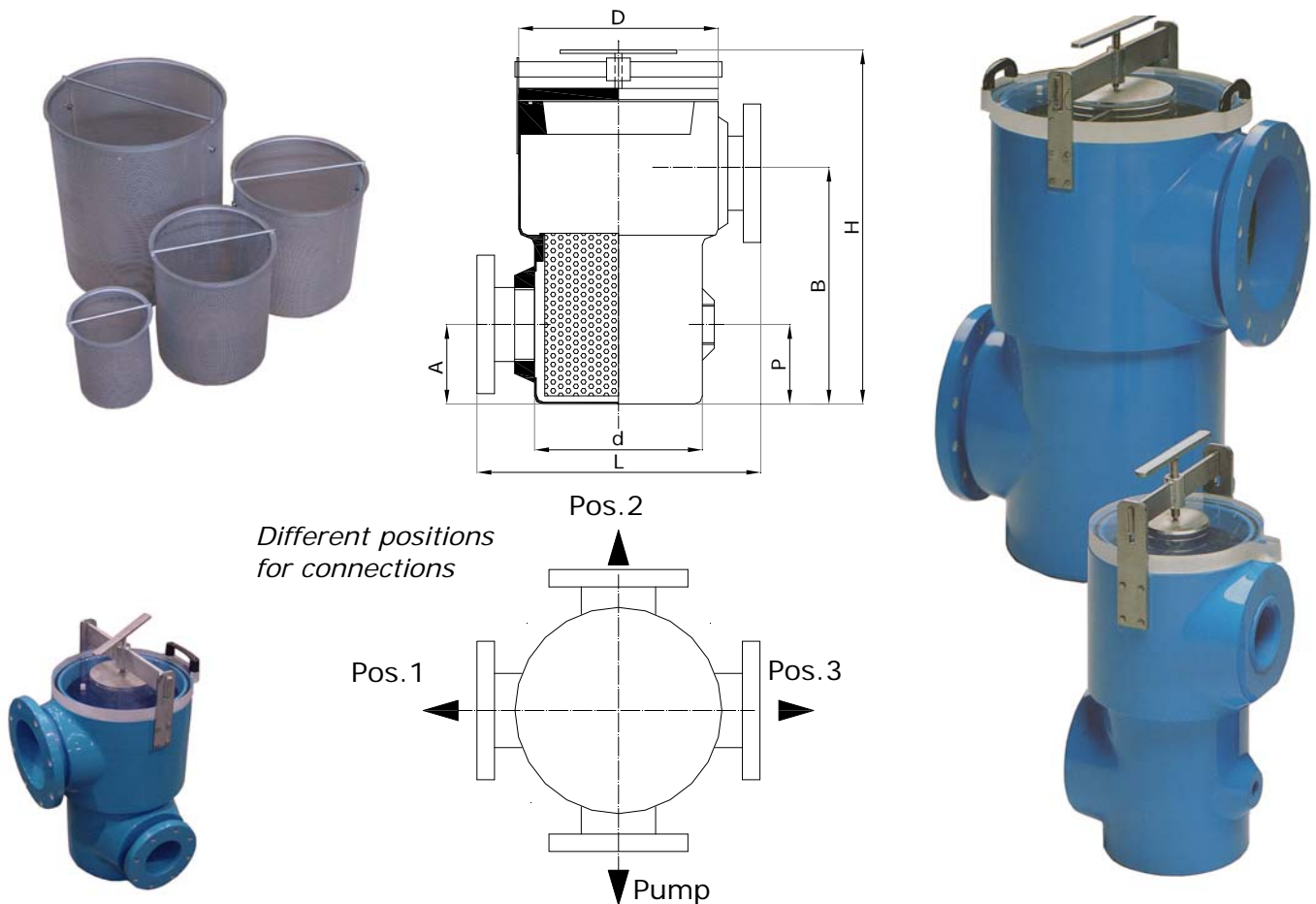

Model	D	d	L	A	H	B	P	DN MIN / MAX	Max Press	Basket Vol.
P4	250	200	370	100	500	290	100	25 / 80	1.2 bar	4 l
P8	305	250	450	130	635	370	120	50 / 150	1.2 bar	8 l
P15	355	300	500	150	760	455	150	65 / 200	1.2 bar	15 l
P25	415	315	560	165	785	495	150	80 / 250	1.2 bar	25 l
P60	530	480	700	260	1030	695	150	110 / 500	1 bar	60 l
P75	530	480	700	300	1260	850	150	250 / 500	1 bar	75 l

Check for threaded connections