

1. DESCRIPTION

DA-Gen is a traditional salt electrolyze unit, working by splitting NaCl into Na and Cl. By this, chlorine is added to the pool water as main disinfectant. Furthermore, free radicals are produced, which supports the chlorine in killing bacteria. The level of chlorine in the pool water is adjustable to the level the user decides and to the level demanded from the standards demanded from the authorities. The unit should be specified to fit the size of the pool, in order to be able to produce sufficient amount of chlorine.

The content of NaCl in the pool water has influence on the production capacity of the unit. Recommended level is between 2000 – 4000 TDS. The volume of the pool and the TDS will specify the size of the unit. By this, the unit can produce any level of chlorine demanded by user. The specification of the unit can be provided of the distributor of the unit. Hydrogen can be lead away from the unit by installing a pipe connection to outside air.



Control panel



- 1 Connection cell 110-230V
- 2 Gasetectorconnection
- 3 Main 230V connection
- 4 ON/OFF switch



- 5 4 Amp fuse for panel and cell
- 6 4 Amp fuse relays

Cell

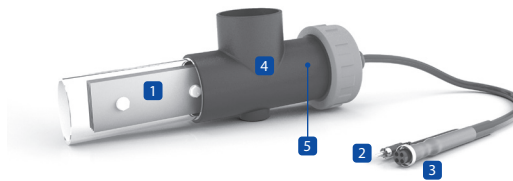

- 1 Cell
- 2 Gas detector connector
- 3 Cell connector
- 4 Cell housing
- 5 Gas detector (internal)¹

¹Except DA-GEN 150

2. MAIN SCREEN

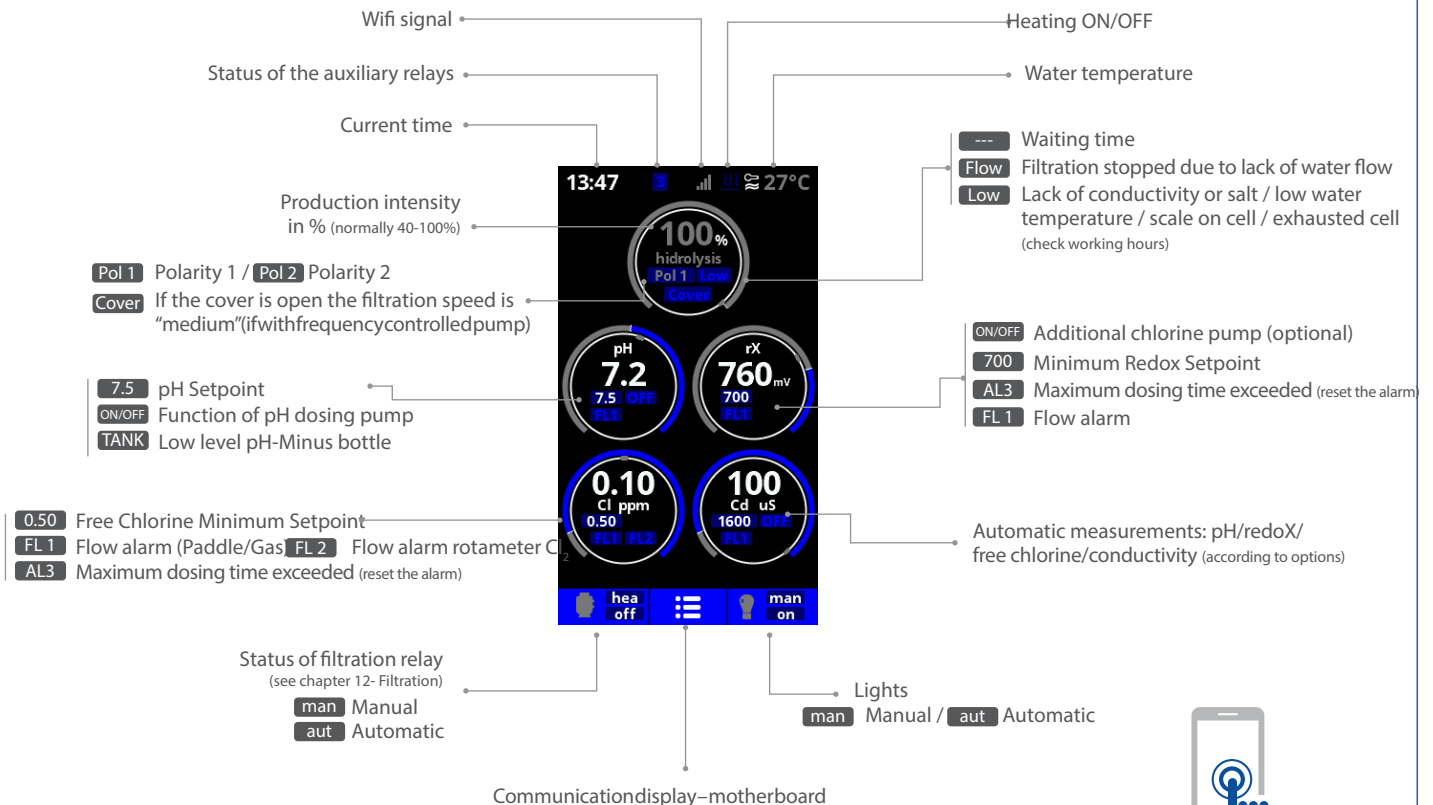

TOUCH SCREEN

3. SYSTEM INSTALLATION

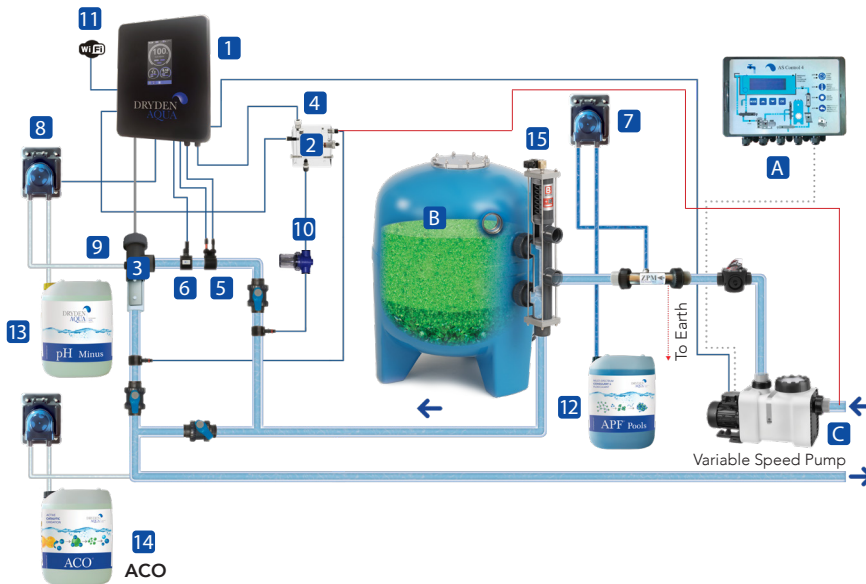

Electrical consumption

Use of a 13 Amp time delay circuit breaker is recommended for private devices and a 16 A breaker for public devices. In case of sharing the power supply with other devices please consult a technician in order to dimension a correct installation.

Product	Maximum consumption	Product	Maximum consumption
DA-GEN 24	90 W	DA-GEN240	680 W
DA-GEN 45	125 W	DA-GEN360	1000 W
DA-GEN 90	180 W	DA-GEN500	1020 W
DA-GEN150	175 W	DA-GEN750	2880 W
Private		Public	

- A** External pump controller*
- B** Filter with AFM*
- C** Filter pump
- 1** Control Panel
- 2** Free chlorine cell with rotameter
- 3** Cell (always in vertical position if installed without paddle flow switch **6**)
- 4** pH probe
- 5** Redox probe and/or conductivity probe
- 6** Paddle flow switch and temperature module
- 7** APF* dosing pump
- 8** pH dosing pump
- 9** pH injection
- 10** Prefilter
- 11** Wifi module (see chapter 15)
- 12** APF* (not included)
- 13** pH-Minus (not included)
- 14** If Outdoor pool: ACO* (not included)
- 15** Besgo valve (not included)

! * Filtration control by external timer

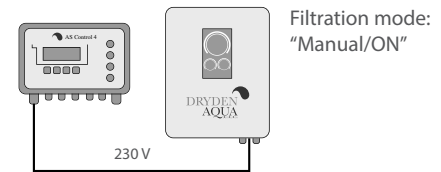

! * Filtration control by internal timer

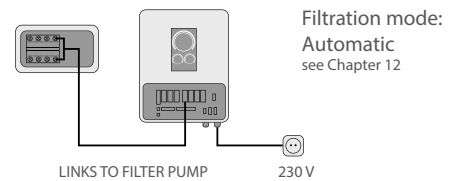

4. ELECTRICAL CONNECTIONS

! CONNECT ALL THE SENSORS CAREFULLY, A BAD CONNECTION MAY CAUSE IRREPARABLE DAMAGE TO THE DEVICE

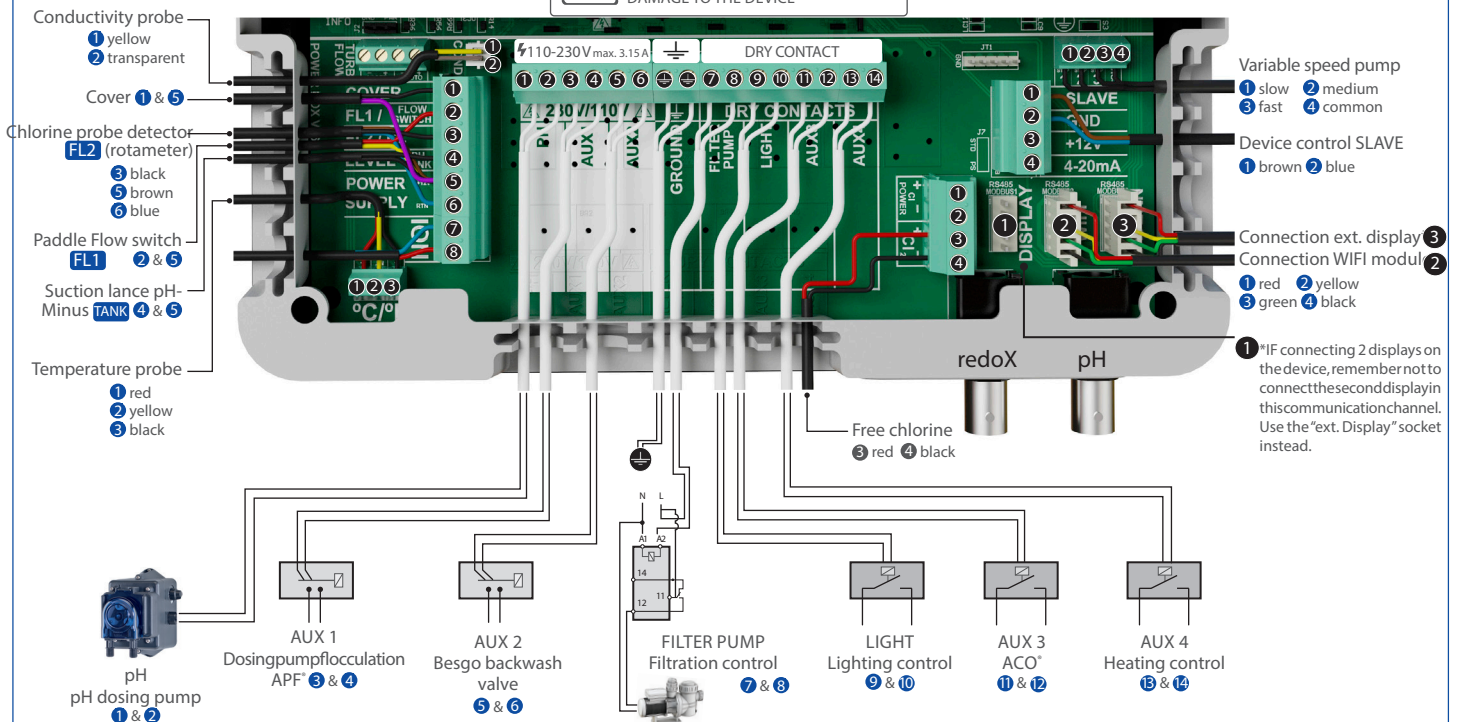

5. WATER PARAMETERS

The following values should be checked:

On a daily basis:

- pH*
 - Total, Free and combined chlorine*
- (* = According to DS477)

On a weekly basis:

- Alkalinity.

Recommended Level: 100-200ppm

Salt level (NaCl) : According to the decided level in the pool

Recommended TDS level is between 2000 – 4000 ppm

The volume of the pool and the TDS will specify the size of the unit to be used.

It is recommended to check and adjust the TDS value once a week.

The only chemical needed for operations of the unit is NaCl.

6. SYSTEM SETTINGS

6.1 Main menu → 6.2 Settings → 6.3 Language → 6.4 Language → 6.5 Time → 6.6 Settings → 6.7 Screen → 6.8 Settings → 6.9 Sound → 6.10 Settings → 6.11 Password → 6.12 Settings → 6.13 System Info → 6.14 Power module

6.3 Language
6.5 Date and Time
6.7 Display brightness

6.9 Sound
6.11 Password: Protect the user's menu by activating a password. To enter your password press a combination of 5 keys and the system will memorise them. If you forget the password, there is a "master password". Ask your installer/provider.

6.12 Cell working hours
6.14 System info: Information about the software versions and the IDNode

7. PADDLE FLOW SWITCH

Paddle flow switch. Stops the chlorine production and the dosing pumps if there is no water flow.

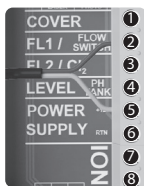

Connect as shown in the image and contact your installer for activation.

8. SUCTION LANCE (pH BOTTLE)

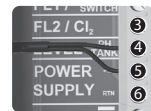

pH-Minus bottle level TANK 4 & 5

Connect the suction lance. The installer/provider should be contacted to activate the sensor.

9. HYDROLYSIS

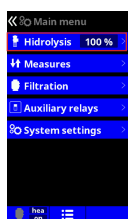

9.1 Hidrolisis: Programming of hydrolysis functions

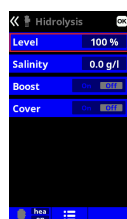

9.2 Level: Hydrolysis - Desired disinfection production (Always 100%). Boost has no effect, leave as off.

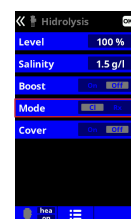

9.3 Mode: If the device has Free Chlorine and redox probes, choose the parameter that controls the cell's chlorine generation.

10. MEASUREMENTS

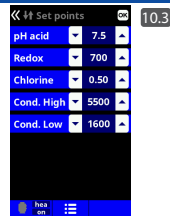
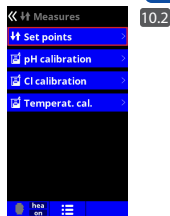
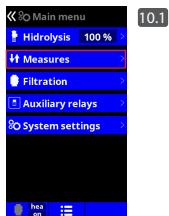

10.1 Measurements: Adjustment of setpoints and measuring probes.
 10.2 Setpoints for each measurement.
 10.3 Setpoints: according to public standards / DS 477

10.1 pH Calibration

pH module

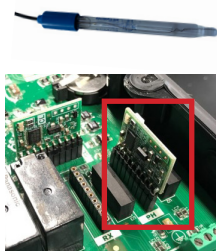

Check if the chip is plugged in correctly and if the green LED is blinking.

(PH/RX label on the left side)

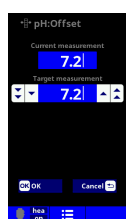
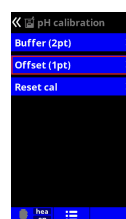
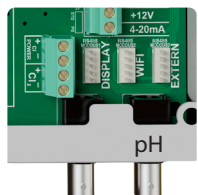
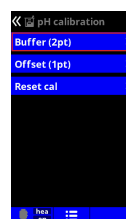
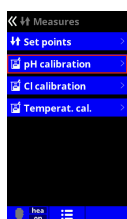

10.11 Calibration of pH probe: Recommended at least every 2-3 months during the usage season. Calibrate it always first with the Buffer (2pt).

10.12 Calibration with buffers (buffer pH7 / pH10 / neutral): Follow the instructions that appear on the display.

10.14 Manual calibration: Allows manual adjustment of the probes – only recommended to correct small deviations in the readings.

10.15 Without removing the probe from the water, use the up/down arrows to adjust the reading so it matches your reference value (photometer or other measurement).

10.2 Temperature calibration

Temperature module



Temperature probe
 1 red
 2 yellow
 3 black

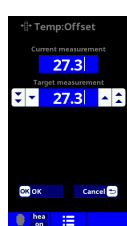
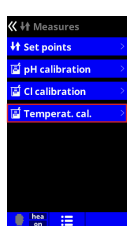
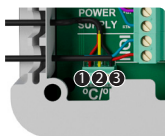

10.22 Temperature calibration: To set the difference between the measured value of the probe and the actual temperature, use the up/down keys. Set to the actual temperature of the probe and press OK.

10.3 Free Chlorine calibration

Free Chlorine control

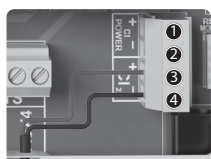

Free Chlorine probe
 3 red 4 black

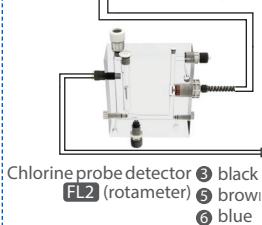

Chlorine probe detector
 3 black
 FL2 (rotameter) 5 brown
 6 blue

If using a Variable Speed Pump, calibrate the probe using the lowest filtration speed.

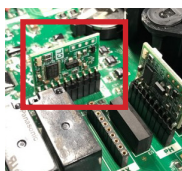

Check if the chip is plugged in correctly and if the green LED is blinking (CL label facing down)

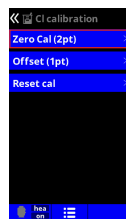
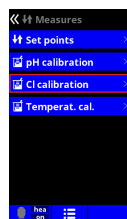

Let the system run 24 hours before calibrating and make sure to have a free chlorine level of at least 0.5 ppm free chlorine!

10.31 Calibration of the Free Chlorine probe: Recommended every month.

10.32 Calibration with buffer (photometer DPD1): Follow the instructions in 7 steps that appear in the display.

10.33 Step 1 of 7 - Calibrate Cl at 0 ppm (offset): Close the water flow through the probe and wait for 5 to 60 min until the reading is close to 0. Press OK

10.34 Step 3 of 7 - Calibrate Cl: Set the water flow to the correct rate of 80-100 litres/hour. Wait for 1 to 10 min until there is a stable ppm reading. Press OK.

10.35 Step 5 of 7 - Establish the real ppm values with the up/down keys according to your DPD1 (free chlorine) value. Press OK.

10.36 Step 7 of 7 - If this screen is not shown repeat the calibration process.

10.38 Manual calibration: Open the water flow and set the flowmeter (rotameter) to the correct flowrate (50-100l/h). Wait until the current level is stable. Set the chlorine level with the up/down keys, manually (use a manual DPD1 test kit). Press OK when value is correct.

10.4 Redox Calibration

The redox value shows the oxidation/reduction potential and is used to determine the sterility of the water. Adjusting the ideal redox level (setpoint) is the last step in the system start up sequence.

Redox control

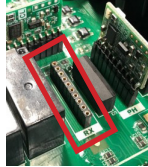
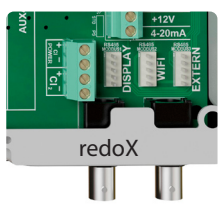

Check if the chip is plugged in correctly and if the green LED is blinking. (PH/RX label on the left side)

Attention: Use only gold redox probes!

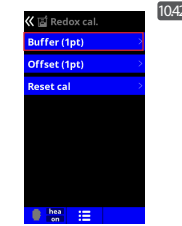
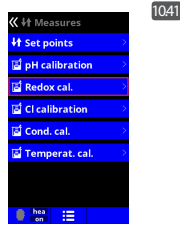

10.41 Calibration of the redox probe: Recommended every month.
10.42 Calibration with buffer (buffer solution 465 mV): Follow the instructions that appear on the display

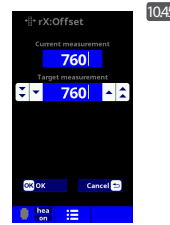
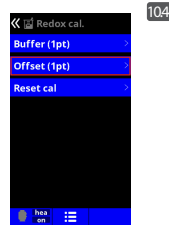

10.44 Manual calibration: Not recommended!

10.5 Conductivity calibration

Optional Conductivity probe

Metering and control of the conductivity of the water in μS

Conductivity probe
1 yellow
2 transparent

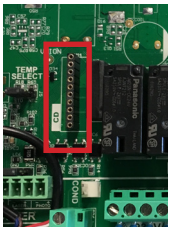
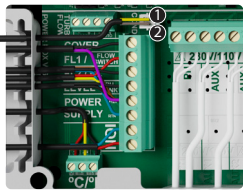

Check if the chip is plugged in correctly and if the green LED is blinking (CDlabel on the left side)

1000 TDS \approx 1800 μS

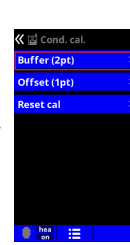
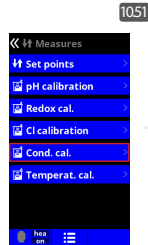

10.51 Calibration of the Conductivity probe: Recommended every month during usage season.
10.52 Calibration with buffer (buffer solution 1413 μS / 12880 μS / neutro): Follow the instructions in 7 steps that appear in the display (screen 4.24 corresponds to step 1).

10.54 Manual calibration: Not recommended!

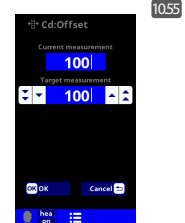
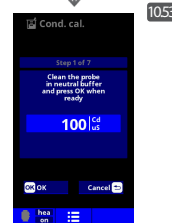

11. VARIABLE SPEED PUMP

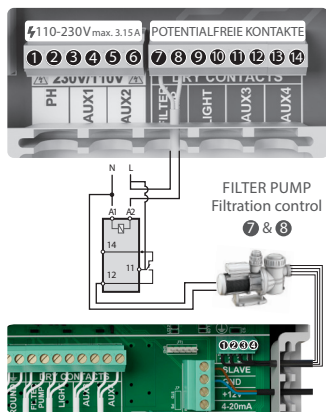

Variable Speed Pump

1 slow 2 medium 3 fast 4 common

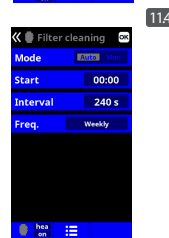
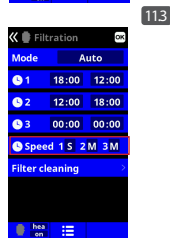
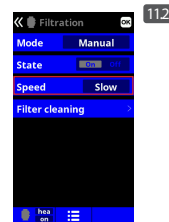
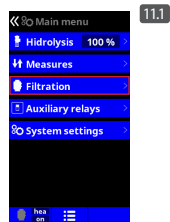

11.1 Variable Speed Pump: To install a Variable Speed Pump contact your installer.

11.2 - 11.5 After connecting the pump, each filtration period can be assigned a different speed F: fast, M: medium and S: slow.

See chapter 12 - Filtration

11.5 Filter cleaning: To backwash the filter with a Variable Speed Pump use the fastest speed.

See chapter 13 - automatic backwash

Please see the wiring schemata in the appendix!

12. FILTRATION

12.1 Manual mode

Only with an external pump controller unit

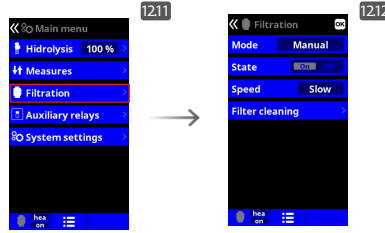
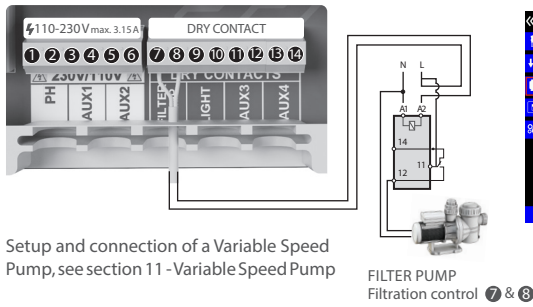

12.11 Filtration:

Configuration control of the filter pump. To set, select Filtration and confirm by pressing OK. The mode selection is done in Mode line with the plus/minus keys.

12.12 Manual:

Manually turns ON/OFF the filtration process. No timing or additional functions. The State (Status) line indicates whether the filtration pump is ON.

12.2 Automatic mode

Without an external pump controller unit

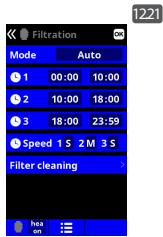

12.21 Automatic

In this mode the filtration is controlled by up to 3 timers.

We highly recommend to run your system in a 24/7 mode with a variable speed pump.

For example: During the night time (6:00 until 24:00 & 0:00 until 10:00) in low speed, during day time (10:00 until 6:00) in medium speed.

To set the ON/OFF times select with the up/down keys in the timer line you want to change (1-3).

The plus/minus keys open the selected start time field. Set the time with plus/minus keys. Scroll with the up key to the minute field and set it up with plus/minus keys. To confirm press OK and to cancel press return/escape.

Backwash: See chapter 13

12.3 Heating mode

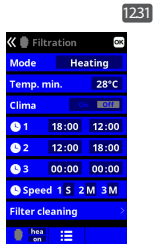

12.31

12.31 Heating: This mode acts equally to the automatic mode, but besides it includes the option to work on a relay to control the temperature. The system works with a hysteresis of 1 degree (example: the setting temperature is 23° C, the system will activate itself when the temperature goes below 22° C and will not stop before it passes 23° C).

Use the plus/minus keys to set the desired temperatures

Clima OFF: The heating only works within the set filtration periods.

Clima ON: Keeps the filtration working when the filtration period is finished if the water temperature is below the setting temperature.

* Note: Mode only visible if the temperature probe is installed and/or heating is activated in the "Installer Menu".

13. AUTOMATIC BACKWASH

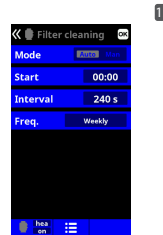

13.1

13.1 Backwash Mode with Besgo Valve: The DA-GEN is configured for automatic backwash with Besgo. Use AUX 2!

- Mode: Choose Auto
- Start: Choose starting time
- Interval: Set backwash time in seconds (Recommendation: min. 240 seconds with AFM®, min. 300 seconds with Sand)
- Freq.: Choose frequency (at least weekly)
- Test

14. LIGHTING

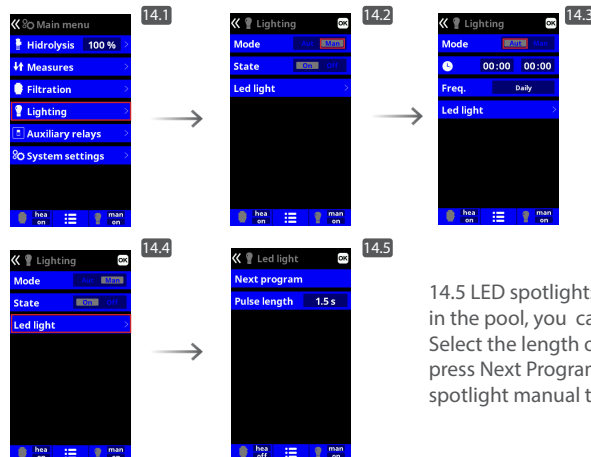
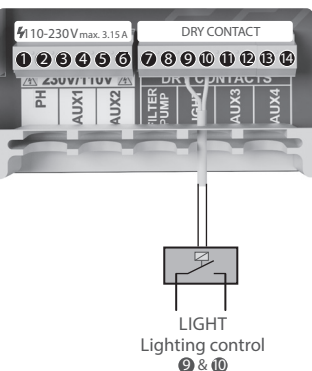

14.1 Lighting

14.2 Manual Mode (ON/OFF). You can activate the light also by pressing the shortcut. You can set a timer, after that the light will go out.

14.3 Automatic Mode: Switches lights according to timer settings. Additionally you can switch the lights on by pressing the Shortcut button

14.5 LED spotlight: In case of installation of RGB LED lights in the pool, you can change the color of the lights in the pool. Select the length of time in seconds in Pulse length and then press Next Program option to apply the pulse. Refer to your LED spotlight manual to set its different colors.

15. WIFI SETTINGS

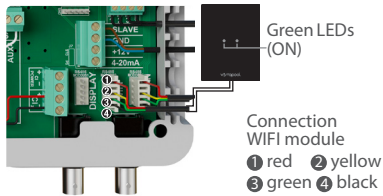

Installation Advice- Connecting the WIFI to the DA-GEN
 Open the WIFI box and unscrew the cables in the box. Put the cable through the cable hole at the DA-GEN controller box and plug it in. Connect the cable then again in the WIFI box and close it.
Do not remove the cables from the plug!

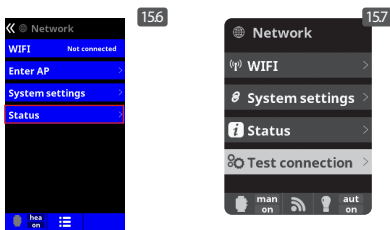
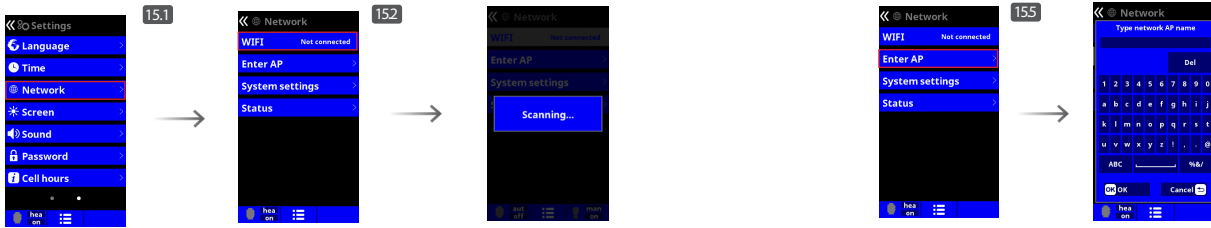

15.1 Internet: Once the WiFi module is connected, restart the unit. The internet option will appear in the settings menu.

15.2 WiFi: Select WiFi to scan the available networks accessible to the module. The search will be done automatically.

15.3 Select the desired network accessible to the WiFi module.

15.4 Enter the password in the pop-up keyboard. Scroll up and down with the up/down keys and left to right with the plus/minus keys. To select a letter press OK.

15.5 Enter AP: If you do not find your Network in the automatic mode, then you can enter the network name manually. Check first if the network works on other devices.

15.6 Status: Check the status of your connection.

15.7 Test connection: Check if your connection has been successfully established.

Once the WiFi module is connected to the network with both lights ON, enter in www.DA-GEN.com. Access

the Register option and enter all the data requested.

15.10 - 15.13 The system node ID that you will need for the registration progress is located under System settings > System info > Power module

Upon completion of the process, you will have total control of your pool, will be able to change parameters such as setpoints, filtration hours and turn ON/OFF any auxiliary relays.

Attention: If the DA-GEN was once registered at vistapool.com it needs to be removed there by the manufacturer before you can register it at DA-GEN.com. Please contact your dealer.

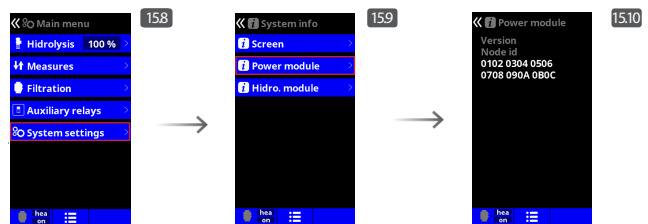

17. COVER

Cover 1 & 6

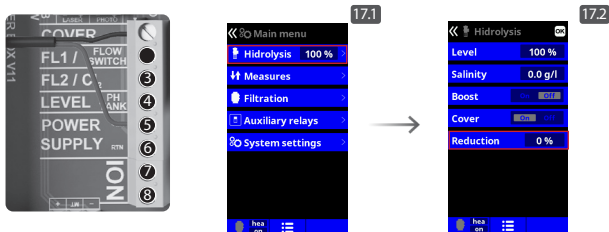

17.1 Cover: If the DA-GEN is runned with a frequency controlled pump and if it is connected to the pool cover, the filtration speed will automatically go to «medium» when the cover is opened. (Please check the filtration speed in Chapter E). Set the Reduction value to 0%!

How to install: If the cover is open, the contact has to be closed and vice versa

18. AUXILIARY RELAYS

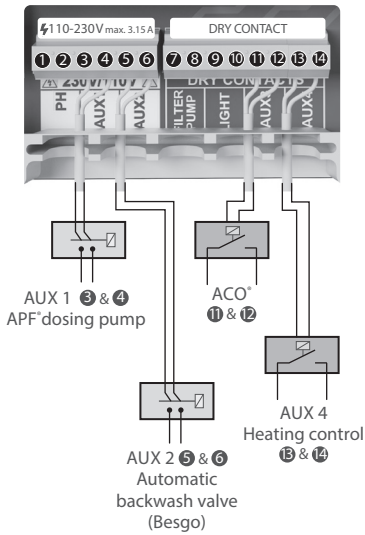

The auxiliary relays are configured by default. If you want to reassign the relays for other accessories, you must access the "Service Menu". Contact your authorised installer.

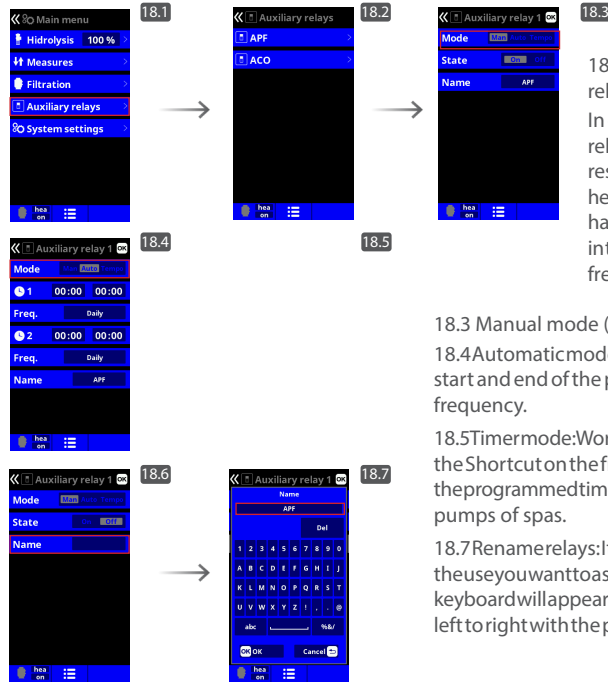

18.2 It is possible to control up to 4 extra auxiliary relays (water attractions, dosing pumps, etc). In default setting you will only see two available relays: APF[®] and ACO[®]: (AUX 1 and 3). AUX 2 is reserved for the Besgo Valve and AUX 4 for the heating and therefore not shown here. If you do not have a heating, you can deactivate it (Chapter C&D in the service manual) and you will get an additional free relay (AUX4).

18.3 Manual mode (ON/OFF).

18.4 Automatic mode: ON/OFF according to a timer that adjusts the start and end of the program. The timers can be configured with a frequency.

18.5 Timer mode: Working time is programmed in minutes. Each time the Shortcut on the front panel is pressed, it will start up and run for the programmed time. This function is recommended for timing of air pumps of spas.

18.7 Rename relays: It is possible to rename each auxiliary relay to suit the use you want to assign. By pressing the plus/minus keys, a pop-up keyboard will appear. Scroll up and down with the up/down keys and left to right with the plus/minus keys. To select a letter press the OK.

19. MAINTENANCE

Weekly checks

SALT CONCENTRATION: ~2000 - 4000 ppm TDS

CELL: Visual inspection to detect incrustations.

Cleaning the Cell

If necessary, carry out a monthly visual inspection. To clean the cell:

- 1 Stop the system and close the valves
- 2 Place the cell for no more than 10 min. in 3% hydrochloric acid or put it for 2 to 4 hrs in normal vinegar or take a high pressure cleaner.
- 3 Once the incrustations have softened remove with a hose to complete cleaning the cell.

DO NOT USE METALLIC OR SHARP OBJECTS TO REMOVE INCRUSTATIONS. Scratching the edges or surface of the cell will make it vulnerable to chemicals, deteriorate the cell and invalidate the guarantee.

General maintenance

- 1 The pool must be vacuumed as usual and the skimmers emptied whenever necessary.
- 2 **FILTER BACKWASHING:** At least once a week for 4 to 5 minutes.
VERY IMPORTANT: Make sure the cell is off while cleaning the filter. If the system controls the filtration pump, use the option "backwash" of the programmed filtration mode. See chapter 13 - automatic backwash
- 3 Check regularly the level of your pH and APF[®] bottle to prevent the dosing pump from running dry.
- 4 pH/Redox/Conductivity – probes: The probes must be cleaned and recalibrated every 2 to 3 months. To clean the probe insert in electrode cleaner. After each clean the probes must be re-calibrated.

Attention: the probes should never dry out and must be kept wet if stored (when emptying the pool for winterising, make sure to store the probe head in water).

20. TROUBLESHOOTING

Blank display

- Check if ON/OFF switch is illuminated.
- Check the connection wire between display and motherboard.
- Check the 3.15 A fuse of the device – it could have tripped due to overload.
- Check the power supply – 230V/50Hz.
- If the problem persists contact TECHNICAL SERVICE

Hydrolysis does not reach the setpoint value

- Low water temperature.
- Check the salt concentration (TDS) in water.
- Check the cell status (it may be incrustated or calcified).
- Clean the cell according to the instructions in section 19.
- Check that the cell is not worn out (remember that the cell is guaranteed for 5,000 hours, approx. 2-3 years of summer usage).

Free chlorine level doesn't reach the setpoint

- Increase the filtration hours to 24 hours
- Increase the hydrolysis level (to 100%).
- Increase the salt concentration (TDS) in the water.
- In an outdoor pool: Add ACO[®] to the water.
- Check if the reagents in test kit are in date.
- Check if the temperature or number of users has risen.
- If you want a higher chlorine level you have to increase the salt concentration. Attention: Higher risk of corrosion!

Hydrolysis display shows FLOW

- Check gas and paddle flow detector cable.
- Clean for incrustations of the paddle flow detector at the top of the cell housing.
- Check to see if system is free of air (gas detector must always be submerged).

Polarity 1 reaches maximum intensity, but polarity 2 (auto clean) does not reach maximum intensity

- If the salt concentration is correct : The cell is reaching its end of life. As of this moment check the intensity every 15-20 days.
- When polarity 2 does not reach intensity of Polarity 1, we recommend substituting the cell for a new one if it happens during the summer period. If it happens during winter, change the cell before the next summer period.

Dosing pump is not working properly

- Check fuse on the right side of the dosing pump
- Check (and change) the dosing speed
- Check electrical connections
- Check tubes and fittings for leaks
- Check if injection valve is blocked
- Check if suction lance/suction weight is blocked
- Check if error message «TANK» appears. If yes replace bottle, if not check the polarity of the suction lance or replace the suction lance

Excess of chlorine in the water

- Lower hydrolysis cell intensity.
- If your system includes automatic Redox control, check the Redox setpoint value. Reduce it by 50 to 100 mV.
- If your system includes free chlorine measurement, adjust the setpoint value.
- Check redox probe and calibrate it if necessary.
- Check the free chlorine probe and calibrate it.

Cell incrustated in less than 1 month

- Very hard waters with a high pH and total alkalinity: balance water adjusting pH and total alkalinity.
- Check to ensure that the system automatically changes polarity approximately every 300 minutes.
- Consult with our technical service to consider accelerating the polarity change (auto-cleaning). WARNING: Accelerating the polarity change decreases the cell life (5,000 hours) proportionally. Don't go below 200 minutes!
- If the crust is not foaming when in contact with acid, it might be Struvite. In this case do not use anymore MgCl₂, use only NaCl.

Alarm AL3 and pH dosing pump stopped

- The maximum dosing time (standard 999 min.) is accomplished and the pH-Minus dosing pump stops in order to avoid the acidification of the water.
- Delete the message and restart the metering. Do the following verifications in order to preclude errors on the device: Verify if the pH probe reading is correct (if not, calibrate the probe or substitute it with a new one); Verify if the acid/base reservoir is full and if the dosing pump is working correctly; Verify the variable speed of the dosing pump.

Rust on metallic components in the pool

- Metallic elements lack standardised earth connection. Contact an electrician to solve the problem.
- Rusted components are not stainless steel (minimum 316/V4A/1.4571).
- The salt concentration (TDS) is too high.
- Attention Stainless Steel parts must be cleaned regularly

21. IMPORTANT NOTES



WARNING

Keep chemical levels in pool as instructed in this manual.

CLEANING FILTER

Very important: Make sure the cell is off while cleaning/backwashing the filter. If the system controls the filtration pump, use the option "filter cleaning" of the programmed filtration mode. See section 5 – Filtration / Filter Cleaning of the General Installation Guide.

VERY IMPORTANT

Remember that the system needs some time to adapt to your pool (up to 14 days)!

SECURITY

To avoid accidents, children should not handle this product unless supervised by an adult. Children should be supervised at all times when in or near spa, pool or jacuzzi.

HANDLING AND DOSING DANGEROUS CHEMICALS

Chemicals should be handled with extreme caution. When preparing acid, always add acid to water, never add water to acid, because very dangerous gases may be produced.

A) ELECTRICAL CONNECTIONS

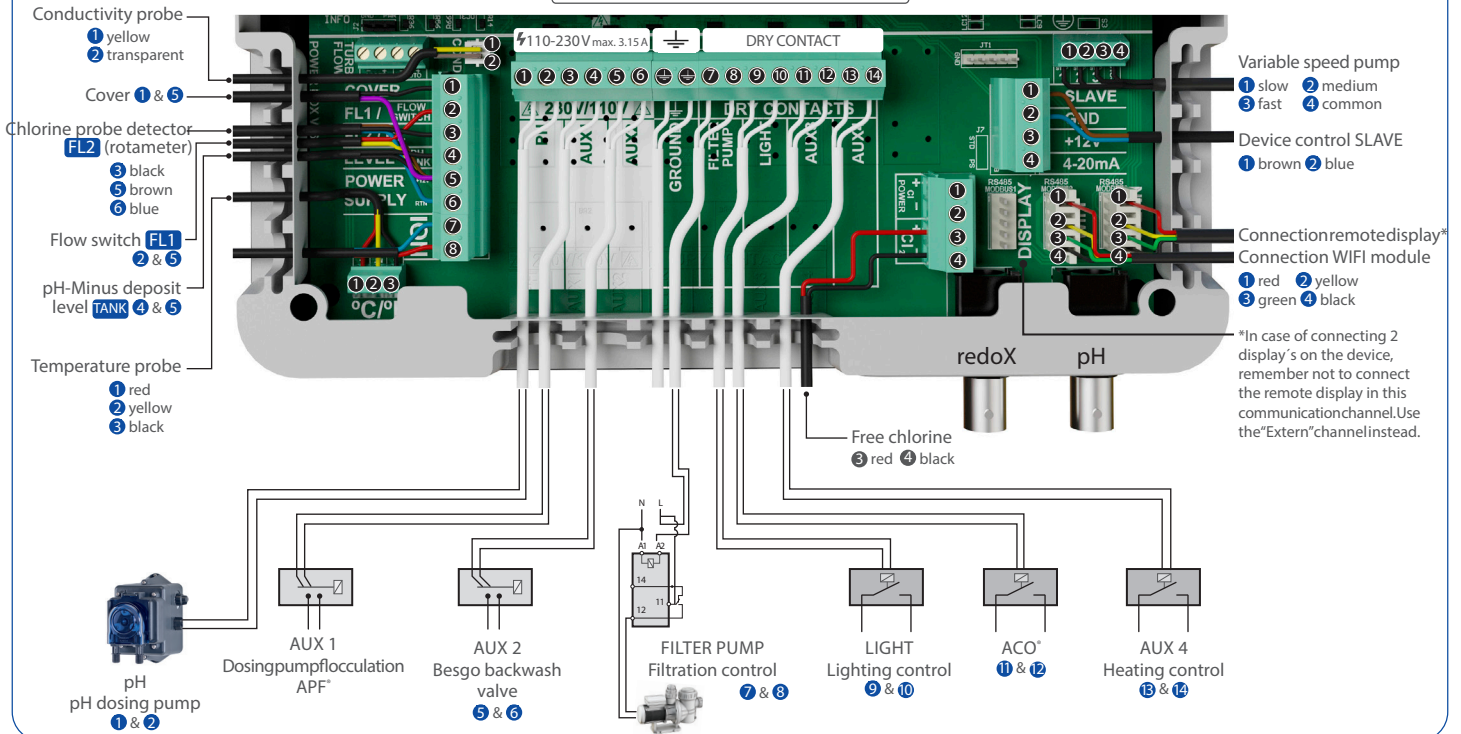
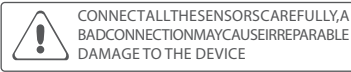

B) SERVICE MENU

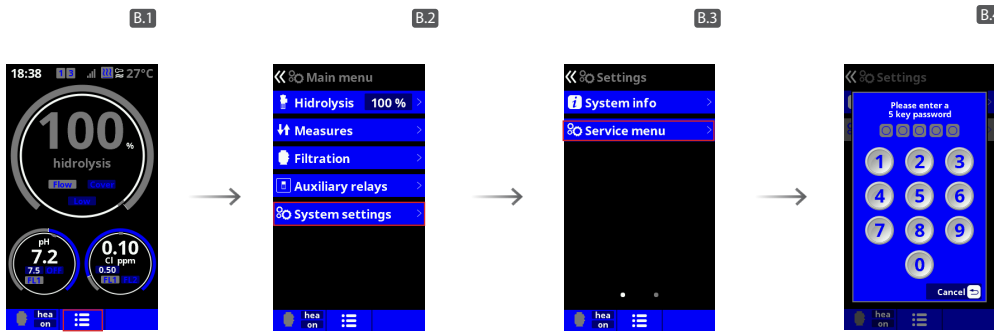

Accessing the Service Menu:
B.1: Main screen (according to model)
B.2: Select System Settings
B.3: Select Service Menu
B.4: Enter password

C) RELAY CONFIGURATION

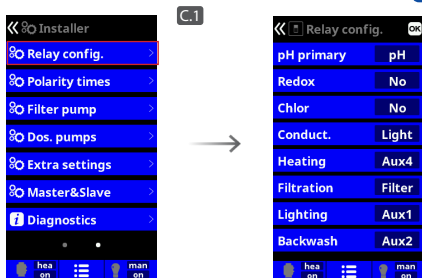

C.1 The 7 available relays can be hooked up to various predefined external devices being controlled by the unit.

C.2 The predefined functions are:
pH: Acid pH-pump.
Filter: Filtration pump.
Light: Pool lights.
AUX 1: APF*
AUX 2: Besgo Valve
AUX 3: ACO*
AUX 4: Heat pump or other heating device.
* Recommended relay settings.

Note: "NO" will deactivate the predefined parameters and leave the relay available.

D) SERVICE SETTINGS

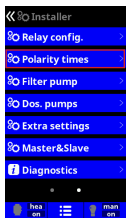

D.1 Parameters related to external devices

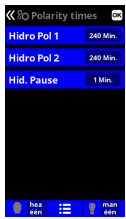

D.2 Setting the polarity times. In the case of high alkalinity, the times in Hydro Pol 1 + 2 should be reduced.

E) TYPE OF PUMP

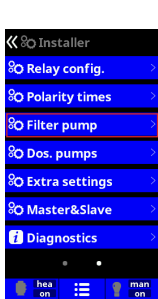

E.1

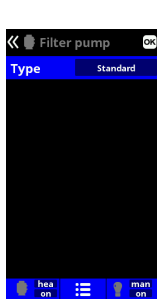

E.2

E.2 With the plus/minus keys, select the pump type connected to the system (the default is a standard pump type). The configuration allows the control of two different variable speed pumps (Variable Speed A or Variable Speed B). In case of a variable speed pump (A or B), establish the speed when the cover is closed, when the pool heating is connected and/or it controls a backwash filter (Besgo).

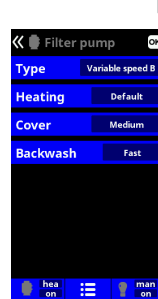

E.3

E.3 Variable Speed Pump A (Hayward® or similar): During the filtration periods, the corresponding relay closes. The filtration pump opens and closes contacts depending on the speed:
 Common + 1 – Slow speed
 Common + 1 + 2 – Medium speed
 Common + 1 + 2 + 3 – Fast speed
 Variable Speed Pump AB (Speck® or similar): During the filtration periods, the corresponding relay closes. It's necessary to connect a wire from the filtration relay to the common. The filtration pump opens and closes contacts depending on the speed:
 Common + 1 – Slow speed
 Common + 2 – Medium speed
 Common + 3 – Fast speed

Consult the wiring-schemata in the appendix!

F) DOSING PUMPS

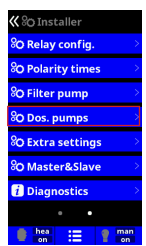

F.1

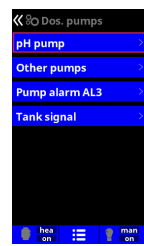

F.2

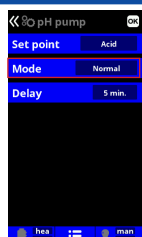

F.3

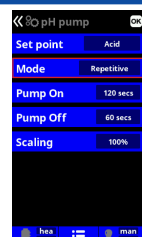

F.4

F.2 There are 2 modes for the pH dosing pump:
 F.3 Normal: Delay-Delay time between detection of incorrect value and the start of dosing.
 F.4 Repetitive: With the two timers you can program the ON and OFF time of the dosing pump
 Scaling: Proportional reduction of the dosing time (Pump On time) when getting close to the setpoint. Example 100%: The pump time is reduced proportionally if the pH is closer than 1 to the setpoint. Example 50%: The pump time is reduced proportionally if the pH is closer than 0.5 to the setpoint.

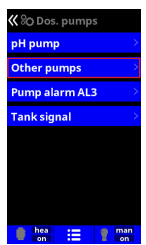

F.5

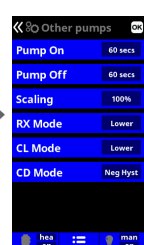

F.6

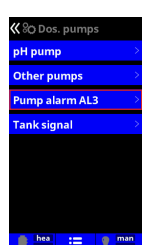

F.7

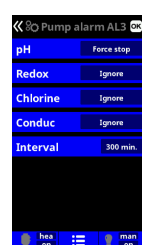

F.8

F.6 Other pumps: With the two timers you can program the ON and OFF time of the dosing pump
 F.8 It corresponds to the behavior of the system after AL3 activation:
 Ignore – AL3 is not shown in the display.
 Inform – After the selected interval, the AL3 alarm is displayed.
 Force stop – After the selected interval, the AL3 alarm is displayed on the display and the dosing pump stops. To reset the alarm and the dosing pump, press

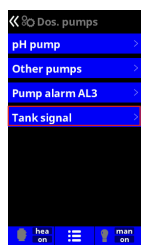

F.9

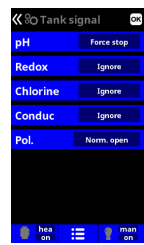

F.10

F.10 You can associate the level sensor (TANK) to the pH or chlorine (rX). This menu corresponds to the behavior of the system after the TANK signal activation (acid deposit level TANK).
 Ignore – TANK is not shown in the display
 Inform – When the sensor detects that the level is low, the TANK alarm is displayed.
 Force stop – When the sensor detects that the level is low, the TANK alarm is displayed and the associated dosing pump stops.

G) EXTRA SETTINGS

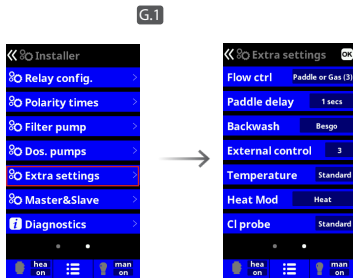

G.2 Gas (0) - The FL1 alarm is only activated by cell's gas sensor (external flow switch annulled).
 Siempre ON (1) - The FL1 alarm is never activated (invalidates cell's gas sensor and external flow switch);
 Paddle (2) - The FL1 alarm is activated by external flow switch (gas sensor annulled).
 Paddle or gas (3) - When both cell's gas sensor and external flow switch are connected, and either of them detects lack of flow, The FL1 alarm is activated. To connect the external flow switch use the FL1 terminal
 Paddle + Gas (4) - When both cell's gas sensor and external flow switch are connected, and both of them detects lack of flow, The FL1 alarm is activated. To connect the external flow switch use the FL1 terminal
 Paddle delay - Delay before FL1 is activated
 Relay control through flow detection - Manage the FL1 alarm deactivation in case of lack of flow. Recommended option for flocculant dosification or similar.

H) COUNTERS

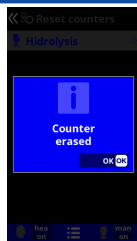

H.2 Reset counters: There are two levels of working hours counters which log the working hours of the components and devices. In this service menu the installer can reset the working hour counters on the first level (for example when a new cell is installed). The second level of the working hour counters can only be accessed by the factory.

I) CONNECTION

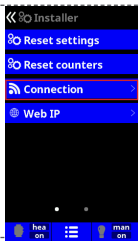

I.2 Node addr: Used for the configuration of more than 2 user interfaces. For normal operation of the system, keep the value to 1 for this parameter.

K) WEB IP



K.2 Server control and connection port in case there is WIFI Module connected to the system. For the proper functioning of the system, do not change the default values unless you receive a notice from your provider.

AL4 - Overproduction alarm / Procedure



Main Menu > Settings > Service Menu > Extra Settings > Hidro Alarm

Cell STOP

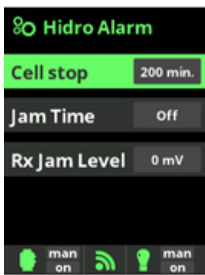

The cell stops producing after maximum time without reaching rX or CI set point .
(ex: 200 min without reaching rX setpoint).

De cel stopt met produceren na een maximale tijd zonder het rX of CI setpoint te bereiken .
(ex: 200 min zonder het rX setpoint te bereiken)

La cellule s'arrête de produire après un temps maximum sans atteindre le point de consigne rX ou CI.
(ex: 200 min sans atteindre le point de consigne rX)

rX Variation

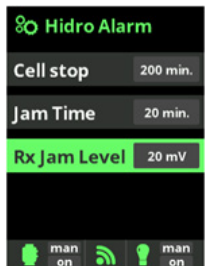

Cell stops after maximum time with readings blocked in a defined range.
(ex: 20 min without rX variation of 20 mV (+/- 5%))

Cel stopt na een maximale tijd met geblokkeerde aflezingen binnen een bepaald interval.
(ex: 20 min zonder rX variatie van 20 mV (+/- 5%))

Arrêt de la cellule après un temps maximum avec des lectures bloquées dans une plage définie.
(ex: 20 min sans variation de rX de 20 mV (+/- 5%))

Both alarms can be activated at the same time.

Very important: this feature is not activated from factory.

ATTENTION!

The settings given in this procedure are for illustrative purposes only and do not constitute a recommended setting.

De instellingen die in deze procedure worden gegeven, dienen slechts ter illustratie en vormen geen geadviseerde instelling.

Les réglages donnés dans ces procédures sont uniquement donnés à titres d'exemple et ne constituent en aucun cas un réglage recommandé.



EU DECLARATION OF CONFORMITY

This declaration of conformity is issued under the sole responsibility of the manufacturer, it is carried out based on tests carried out under the tutelage of the regulatory agency designated by the manufacturer.

Product Description: Saline Chlorinator

Product reference:

OX0NG – OX1NG – OX2NG – OX3NG

- **Declaration of Conformity L.V.D - Low voltage according to LVD Directive 2014/35/EU**
Harmonized standard: EN 60335-1:2012 + AC:2014 + A11:2014 + A13:2017 + A1:2019 + A14:2019 + A2:2019 + A15:2021; EN 62233:2008 + AC:2008
Test number: SAFEKRIPS220601
- **Declaration of conformity C.E.M - Electromagnetic compatibility in accordance with the ECM Directive 2014/30/EU**
Harmonized standard: EN 55014-1:2021, EN 55014-2:2021, EN IEC 61000-3-2:2019 + A1:2021, EN 61000-3-3:2013/A1:2019, IEC 61000-3-3:2013/A2:2021, IEC 61000-3-11:2019
Test number: EMCOKRIPS220601, EMFIKRIPS220601
- **RoHS Declaration of Conformity under the Directive on the Restriction of the Use of Certain Hazardous Substances in Electrical and Electronic Equipment (RoHS) 2011/65/EU and Amendment (EU) 2015/863**
Harmonized standard: EN IEC 63000:2018, UNE-EN IEC 62474:2019, EN 62321 * (8 STD determination)
- **Declaration of conformity Ecodesign according to Directive 2009/125/EC**

We certify the conformity of the products with the corresponding standards, listed in this declaration, provided that their installation and use comply with the prescribed standards.

Place, date: Yuncos, 28/11/2023

Authorized signature: _____

Carlos Martínez Ortega

Technology Knowledge Manager, Europe